

The Hänchen range

From the cylinder to the complete drive system



HÄNCHEN[®]

There's no limit to possibilities for application of hydraulic drives.

No matter under which conditions a hydraulic cylinder should work for you, we make it possible – from rugged to precise use! With a complete system that is custom-made for your requirements.

When you choose Hänchen as your partner, you will benefit from our decades of experience in the field of industrial hydraulics in numerous industries and applications.

- Steel/rolling mill
- Foundry
- Testing technology
- Automotive
- Railway technology
- Machine tools
- Plastic injection molding/
blow-moulding machines
- Presses



Hänchen. Hydraulics are in our genes.

Company	4
Hydraulic cylinders	6
Clamping unit Ratio-Clamp®	24
Pressure transformers & fluid separators	26
Machine elements	28
Technical data	32
Addresses & contact	Insert



- 1 Management: Matthias, Tanja and Stefan Hänchen (from left)
- 2 The Hänchen head office in Ruit near Stuttgart. In our certified company we create sustainable and future-oriented drive solutions.



Hydraulic solutions from a reputable company.

Hänchen. A family business in its third generation.

The passion for hydraulic cylinders and drive systems is hereditary. At least with us it is. We are the third generation to continue the work of our grandfather Herbert Hänchen. With the same pioneering spirit, the same passion for first-class quality and the same enthusiasm for the smell of oil and metal.

Everything started in 1925 with repairing motors: especially precise and long-lasting cylinders and crankshafts were needed. The solution was to hone the surface – a method we're still using today.

Our passion for robust and reliable products is the reason why we have been concentrating on hydraulic cylinders as our core competence since 1952.

With more than 200 highly motivated employees, we have been developing, testing and manufacturing innovative solutions for our customers – in our own research and production departments in Germany. We are at home wherever service life, reliability and availability matters – the best proof of this are our cylinders that have been running without failure for up to 40 years.

Hänchen's success story is still running smoothly. Hänchen's complete service ranges from personal consulting to the interactive product configurator HäKo. From the planning phase to the start-up. From individual cylinders and clamping units to entire drive systems. From standard to special applications.



Our passion.
Long service life.



Hydraulic cylinder		Herbert Hänchen GmbH & Co. KG Brunnwiesenstr. 3, 73760 Ostfildern	
Serial no.	S055747	Year	2013
Bore	80	Port cap-side	G 1/2
Rod Ø	40	P max ext.	150 bar
Stroke	200	P max retr.	150 bar
		head-side	G 1/2
		Made in Germany	

1 Type plate on every Hänchen cylinder: the serial number enables completely identical re-production of the cylinders and 100 % replacement of spare parts.
To facilitate quick replacement of seals, we keep them in stock for you.

Passion for high-quality hydraulic cylinders needs a basis of accuracy down to the last detail. Our cylinder production makes no compromises on quality, giving you every reason to choose Hänchen products: 80 % vertical integration. 100 % made in Germany. 100 % quality.

+ Low friction. Low wear. Long service life.

The high surface quality and geometrical accuracy of the component parts of every single Hänchen cylinder guarantee a long service life without failure.

Honed surfaces

For the best lubrication and running properties and as little wear as possible on cylinders and seals, the cylinders' sliding surfaces are refined with a cross-hatch finish.



Current sealing technology

The constant development of our sealing systems – by combining already marketed and in-house developed seals – optimises our cylinders regarding wear, friction and leakage.

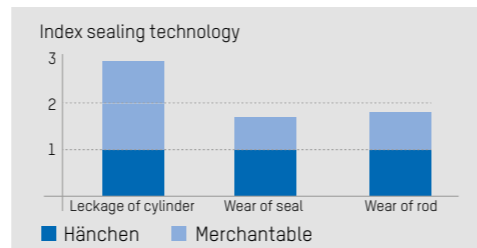

H7/f7 – Clearance fit

The guide clearance must be neither too small nor too large. This is why Hänchen places so much importance on optimal accuracy. The result is reduced stress on guidance and thus less wear on components.

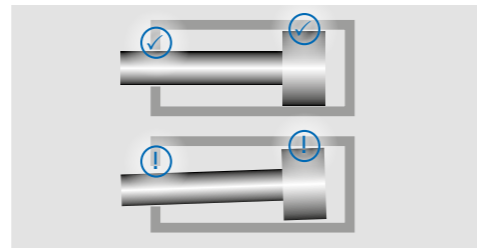

+ Three components. One unit. Easy handling.

The fewer components a cylinder has, the less accident-prone it is. Even maintenance and installation are simpler and safer. The three main parts of a Hänchen cylinder:

Piston rod

In Hänchen products, piston and piston rod are inseparably joined. The piston is coated with non-ferrous metal, enabling a precise metallic guide. The sophisticated rod ends with rounded edges permit a seal-friendly installation.

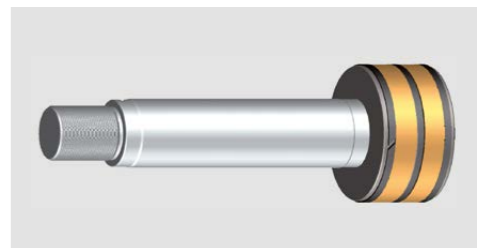

Cylinder tube

Round-head design, inseparably welded to the cylinder mounting. Drilled ports permit a space-saving installation with many options for adjustment to various applications.

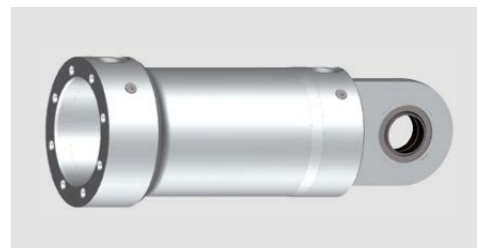

Cover

A cover type perfectly coordinated to the requirements is crucial for the service life of the entire cylinder. Special feature: the synthetic guide is permanently integrated, reaches a better load distribution and minimises the risk of scratches caused by dirt particles.

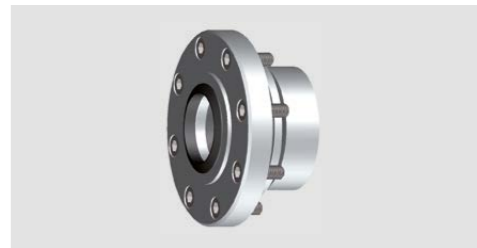



Best performance made easy.

Hydraulic cylinders have a lot of advantages: they are long-lasting, low-friction and robust.

+ Good to go: full speed ahead under full load

The compact construction with low inertia resistance guarantees a high power density. The cylinders can start moving immediately from standstill fully loaded, and can quickly change direction.

+ On position: in every situation

Speed adjustment is stepless with a simple control concept and high positioning accuracy – even when requirements vary greatly.

+ Fast: even under high loads

Force and speed are continuously and simultaneously available at full capacity.



Technical data standard cylinders

Series	Max. pressure (bar)	Bore (mm)	Force (kN)	Stroke (mm)
120	120/150/200*	12–600	1–5,655	1–6,000
300	300*	25–600	10–8,483	1–6,000

Type of effect: single-rod, double-rod
Sealing systems: basic design, Servocop®, Servoseal®, Servofloat®

* Depending on mounting and size
You can find detailed specifications on page 32.



- 1 Folding machine: connecting the outer and inner parts of doors
- 2 Grinding wheel press: force and displacement controlled application of the closing force profile
- 3 Plastic injection machine: retraction of the upper two rods to remove the tool



We provide mounting plates, sensor technology, spherical rod eyes, flanges, clevis brackets and grade 12.9 screws.

+ Cylinders for every frequency range

The required dynamics of the drive determine the cylinder's type of effect. When fast control valves are used, even single-rod cylinders achieve a high profile quality at high frequencies.

The limit values shown in the diagram are intended as guide values for your design. They depend on various operating conditions – we can help you make the right choice.

Suitability of cylinder series according to frequency range

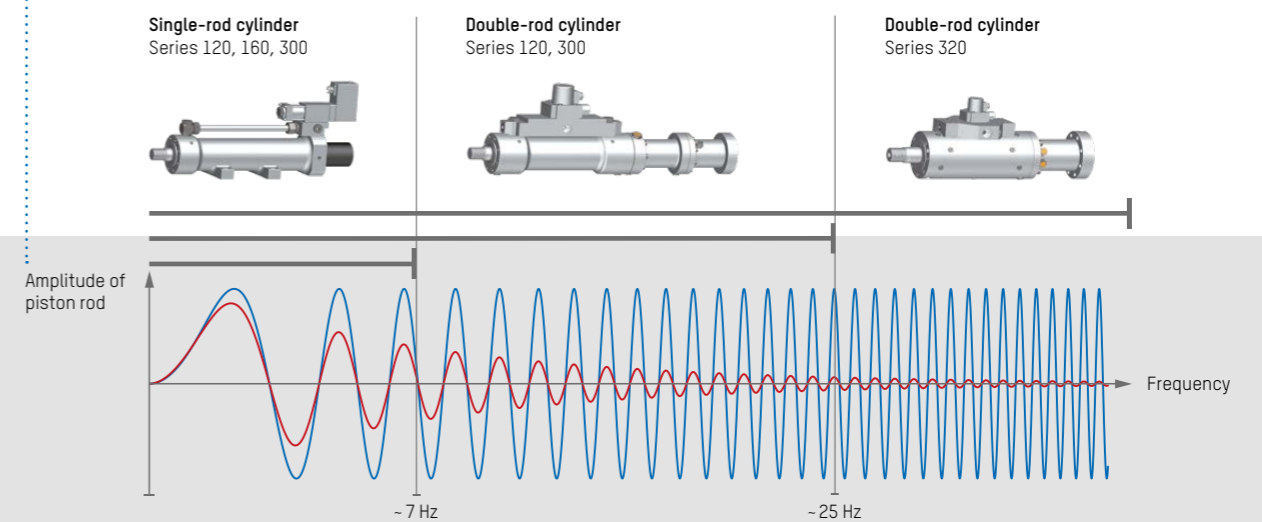

HAKO

You can find the exact dimensions and the data sheets in our product configurator at www.haenchen-hydraulic.com.

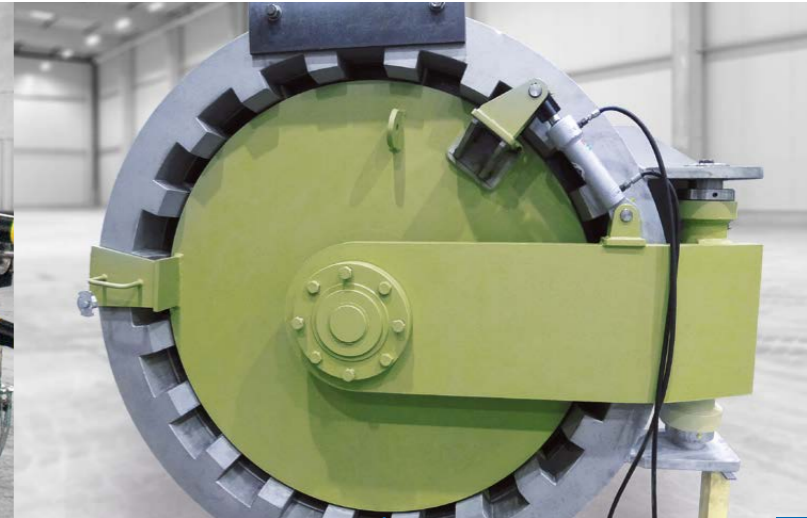
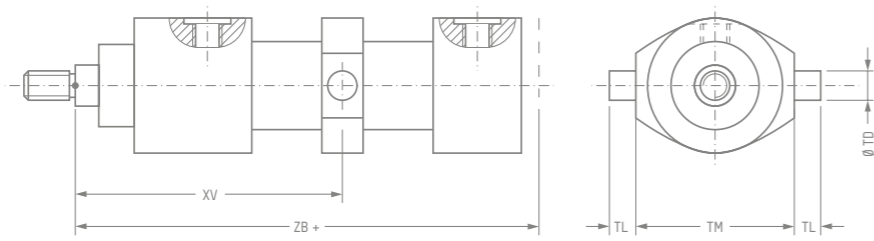

Standard outside. Hänchen inside.

Honed surfaces, geometrical accuracy, long service life. Although the mounting dimensions and accessory options are according to applicable standards, these series convince through their inner Hänchen values.

+ Series 100, 160, and 250: cylinders according to standard

For all those who are obliged to use hydraulic cylinders with mounting dimensions according to DIN 24336 or ISO 6020-1/6022: our series matches the standard dimensions. With all the benefits you've come to expect from Hänchen.

Technical data standard cylinders DIN & ISO

Series	Max. pressure (bar)	Bore (mm)	Force (kN)	Stroke (mm)
100 DIN 24336	100	25 – 125	5 – 123	1 – 6,000
160 ISO 6020-1	160	25 – 200	8 – 503	1 – 6,000
250 ISO 6022	250	25 – 200	49 – 785	1 – 6,000

Type of effect: single-rod (with cushioning)
Sealing systems: basic design, Servocop®

You can find detailed specifications on page 33.



+ Series 550: Hänchen compact construction plus standard mounting dimensions

Cylinders with mounting dimensions according to ISO 6022 with even more Hänchen advantages. We elongate the piston rod to adapt Hänchen cylinders of the series 300 to the standard dimensions of the series 250.

The result:

- Compact, lightweight construction
- Low inertia moment in case of transverse acceleration
- Available with/without cushioning
- Optimal price-performance ratio
- Compatible with standard accessories

Technical data standard cylinders DIN & ISO

Series	Max. pressure (bar)	Bore (mm)	Force (kN)	Stroke (mm)
550 according to ISO 6022	250	40 – 140	31 – 385	1 – 6,000

Type of effect: single-rod (with/without cushioning)
Sealing systems: basic design, Servocop®, Servofloat®

You can find detailed specifications on page 33.

- 1 Tip: always compare the standard dimensions of different manufacturers since the standard allows tolerances
- 2 Parabolic rolling machine: production of special leaf springs
- 3 Pressure container: hydraulic quick-release shutter



We provide matching accessories according to ISO 8132/8133.



You can find the exact dimensions and the data sheets in our product configurator at www.haenchen-hydraulic.com.

High force.
Full control.

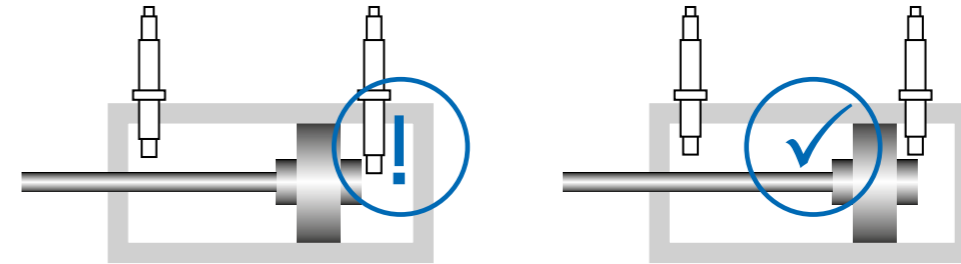
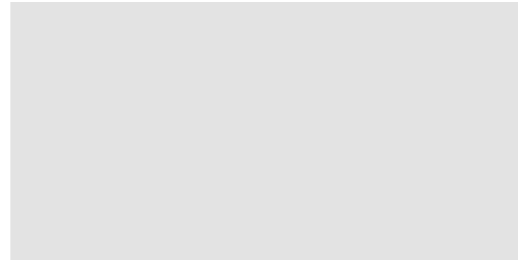

1 A "deep stop" prevents possible crashes. Hänchen proximity switches can't go in too far.

For the necessary sensitivity, Hänchen offers convenient sensor technology components and valves – all for highly dynamic, precise drives with high energy density.

To operate the drive in an Industry 4.0 environment, sensors can also provide data for condition monitoring:

- Pressure transducers in the chambers analyse the friction behaviour
- Temperature and colour sensors provide information on the condition of the fluid
- Online particle counters indicate the degree of contamination of the system
- Flow sensors on the functional oil channel indicate the need for a seal change

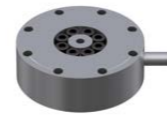

+ Force transducer

Force transducers use strain-gauge or piezo-technology and measure the retracting and extending forces of the hydraulic cylinder. They are installed directly on the piston rod and measure the load on the piston rod statically or dynamically. Force transducers are used e.g. for monitoring or controlling the cylinder force.



+ Proximity switch

Pressure-resistant inductive proximity switches detect the end positions of the stroke in the hydraulic cylinder – wear-free and without contact. The signal is used to check or control the hydraulic cylinder. Hydraulic cylinders with proximity switches also feature adjustable cushioning.



+ Position transducers

Position transducers show the position of the piston rod electronically. An analogue or digital travel signal can be generated using the stroke. This can be used e.g. as an actual-signal in the position control circuit, or for monitoring position or speed limits. A position transducer can be integrated in the cylinder, making a compact, mechanically protected system.



+ Valves

Control valves regulate the flow rate in proportion to the electrical select signal. Depending on the application case, valves with hydraulic pilot control or directly proportional solenoid-controlled valves are used. Valves with zero overlap of the control edges are especially suitable for hydraulic control tasks.

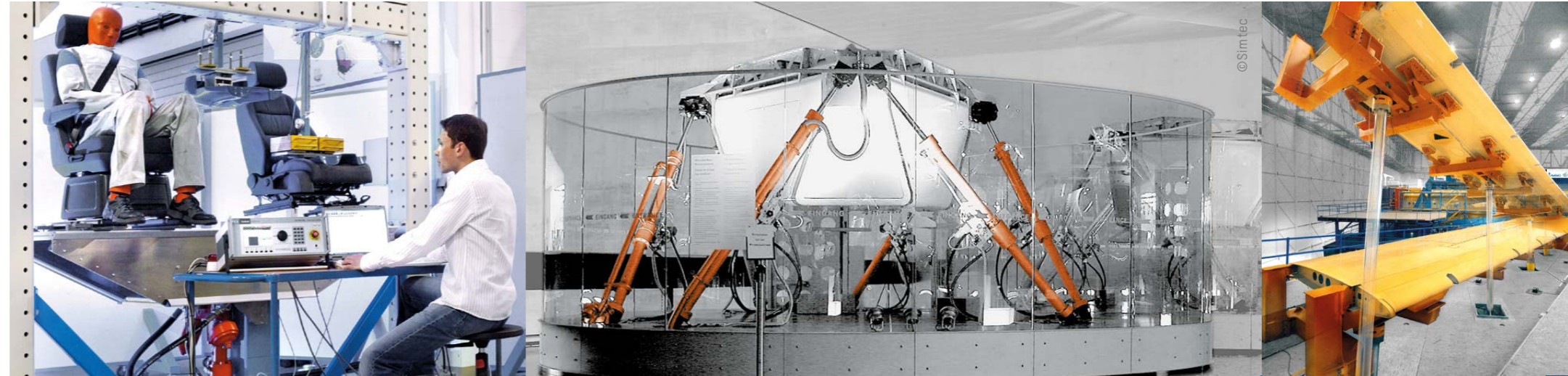

- 1 Test stand for seats: service strength test for vehicle seats
- 2 Hexapod: simulation of a driving route
- 3 Material test stand: long-term test of airplane wings



More information about our test actuators can be found in our brochure "Testing technology".

Dynamics for test winners.



Our two variants for high speeds, frequencies and accelerations:

+ Perfect for highly dynamic industry and test tasks

- Industrial applications – from friction welding and mould oscillation up to sinter metal pressing
- Checking the functional safety of systems, components or products
- Structure tests of airplanes, automobile exhaust systems, refrigerating compressors and many more
- Load and movement simulations, e.g. operational profiles and flight profiles

+ Servo cylinders of the series 120 and 300: perfect for tasks with long strokes

In their typical Hänchen quality with harmonised sealing elements and integrated position transducers, these cylinders fulfil highest technical requirements – for safe and reliable drive control.



+ Test actuators of the series 320: efficient for varying applications

Compact, versatile, quick, sensitive and robust – the best choice for challenging tasks.

- Suitable for every frequency range thanks to its thick-walled design
- Quick and cost-efficient remodelling the cylinder thanks to compatible mounting elements and accessories
- Working without a leak oil pump, with variable bores for adaptable cylinder areas – meaning lower acquisition/operation costs, and also energy efficient due to a smaller hydraulic system
- Stable, steady and admissible for high lateral forces

Technical data servo cylinders

Series with PT	Max. pressure (bar)	Bore (mm)	Force (kN)	Stroke (mm)
120	150*	40–180	19–382	1–1,500
300	300	50–140	59–462	1–1,500

Type of effect: single-rod, double-rod
Sealing systems: basic design, Servocop®, Servoseal®, Servofloat®

* When mounting with pivot mounting, the pressure is limited to 120 bar.
PT = Position transducer
You can find detailed specifications on page 32.

Technical data test actuators

Series	Max. pressure (bar)	Rod Ø (mm)	Force (kN)	Stroke (mm)
320	320	25–160	up to 1,568	50–450

Type of effect: double-rod
Sealing systems: Servoseal®, Servofloat®, Servobear® functional oil seal

You can find detailed specifications on page 34.



You can find design and calculation assistants in our product configurator at www.haenchen-hydraulic.com.

Unlimited possibilities.
Accurate fitting combinations.



For further details on this and other equipment features, please refer to our book "Hydraulic Systems".

High temperatures in steel mills, high stress in outdoor applications, hygiene requirements in food processing: we'll tune your cylinder. Tell us what you need – only those who set conditions get the perfect cylinder.

Equipment in the cover

For the perfect combination, the cover type with the best sealing and guiding system* with matching quality of piston rod and the right sealing material is selected based on your application.

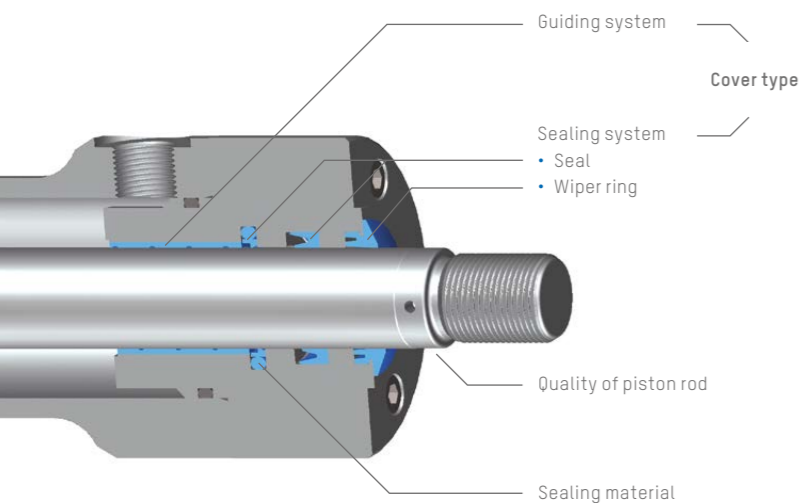

SEALING SYSTEM

Basic design

Lip seal, wiper ring

Servocop®

Compact seal, lip seal, wiper ring

Servoseal®

Servoseal®, lip seal, wiper ring

Servofloat®

Floating gap seal, functional oil seal, wiper ring

Functional oil seal

Functional oil seal, wiper ring

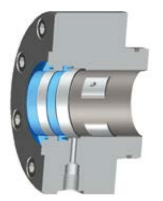
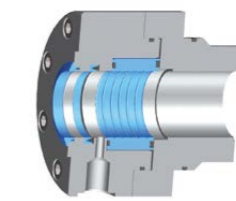
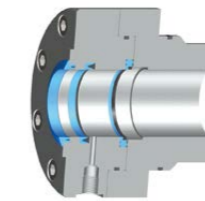
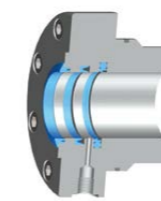
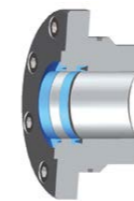

GUIDING SYSTEM

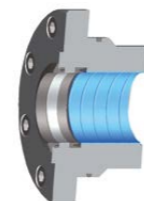

Servoslidex®
Synthetic guide

- Simple movements
- Long-stroke oscillations
- Side loads due to lateral movement
- Low stick-slip
- $v \leq 0.5 \text{ m/s}$

- Controlled movements
- Long-stroke oscillations
- Side loads due to lateral movement
- Mostly stick-slip-free
- $v \leq 2 \text{ m/s}$

- Sensitive movements
- Long- and short-stroke oscillations
- Side loads due to lateral movement
- Low-wear
- $v \leq 2 \text{ m/s}$

- Sensitive movements
- Long- and short-stroke oscillations
- Side loads due to lateral movement
- Low-wear
- $v \leq 2 \text{ m/s}$

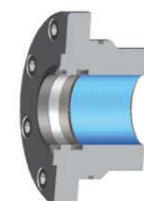

Metallic guide

- Simple movements
- High temperatures
- Universal application
- Low stick-slip
- $v \leq 0.5 \text{ m/s}$

- Simple movements
- High temperatures
- Mostly stick-slip-free
- $v \leq 1 \text{ m/s}$

- Simple movements
- Temperatures up to 80 °C
- Low-wear
- $v \leq 1 \text{ m/s}$

- Simple movements
- High temperatures
- Low-wear
- $v \leq 1 \text{ m/s}$

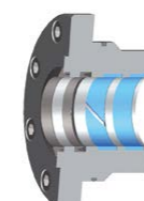

PTFE Wear rings

- Controlled movements
- Long-stroke oscillations
- Side loads due to lateral movement
- Long cylinder stroke
- Mostly stick-slip-free
- $v \leq 3 \text{ m/s}$

- Sensitive movements
- Long- and short-stroke oscillations
- External side loads or due to lateral movement
- Low-wear
- $v \leq 2 \text{ m/s}$

- Sensitive movements
- Long- and short-stroke oscillations
- External side loads or due to lateral movement
- Low-wear
- $v \leq 4 \text{ m/s}$

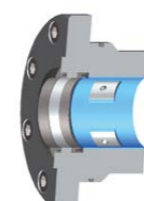

Servobear®
Hydrostatic bearing

- Sensitive movements
- Short-stroke oscillations, highly dynamic
- Highest side loads
- No leak oil pump required
- $v \leq 4 \text{ m/s}$

* The recommended cover type also depends on the series and the piston equipment.

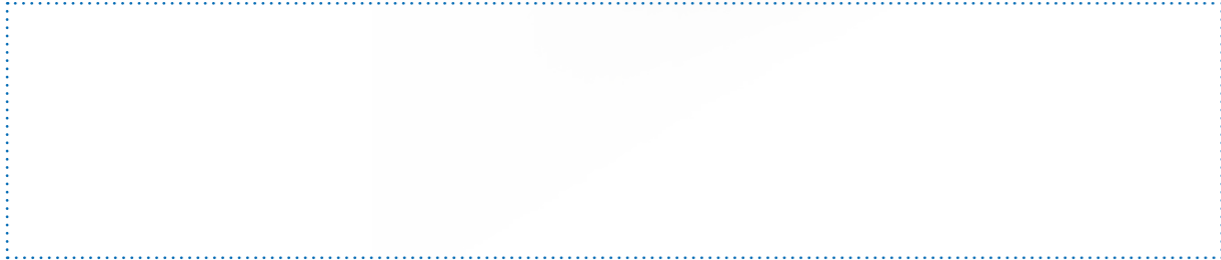

+ Low level of friction force

Whether sensitive, free-moving or robust – the strength of Hänchen cylinders is in their extreme adaptability.

Depending on what you need, we offer you the right cover type with optimal friction force for your static or dynamic application.

Friction in dependence on sealing and guiding system in the cover

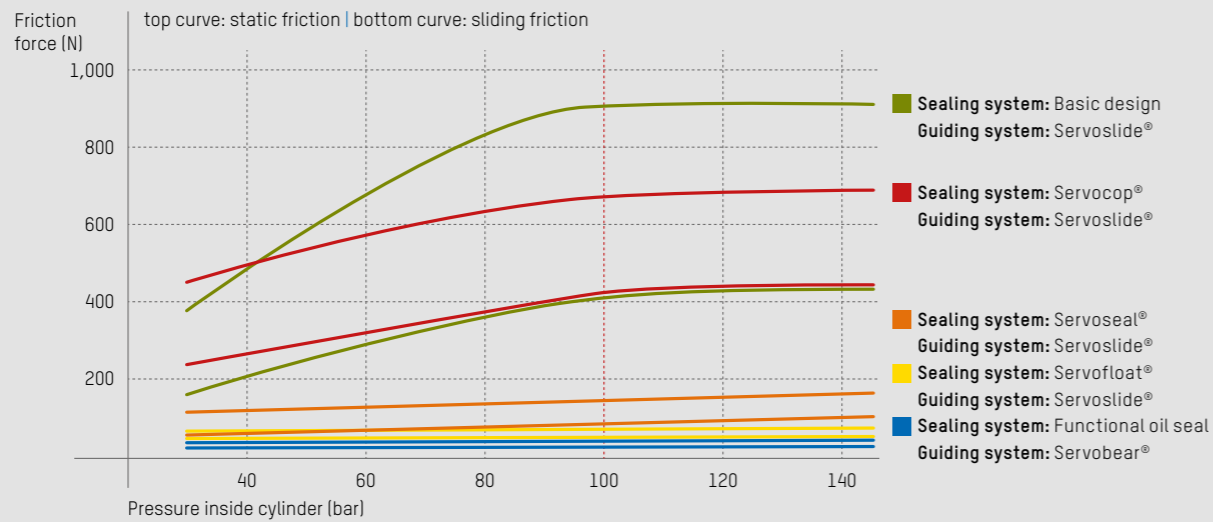

Values measured on the double-rod cylinder (bore 46 mm without seal, rod Ø 40 mm) during sine operation according to VDMA24577 at 50 °C/HLPD46. The level of the friction force curves is lower than usual on the market.



Don't hesitate to contact us, we will be pleased to advise you! You can find our contact details on the insert.

+ The perfect sealing system on the piston

Beside the selected cover type, the right piston design is also crucial for the dynamic movement of the cylinder.

If the cylinder is to be held in position under load for a longer period of time during operation, the rectangular compact seal can be equipped with a static elastomer seal for load-holding function. This prevents possible lowering of the piston rod.

Equipment on the piston

SEALING SYSTEM	Rectangular compact seal	Servoseal®	Throttle gap (without seal)
GUIDING SYSTEM			
Metallic guide	<ul style="list-style-type: none"> • Simple movements • Long-stroke oscillations with movements longer than the seal width • Piston leakage: none • Pressure-dependent friction • $v \leq 4$ m/s 	<ul style="list-style-type: none"> • Sensitive movements • Long- and short-stroke oscillations • Piston leakage: very low • Low friction • $v \leq 4$ m/s 	<ul style="list-style-type: none"> • Sensitive movements • Long- and short-stroke oscillations • Piston leakage: high • Very low friction • $v \leq 4$ m/s

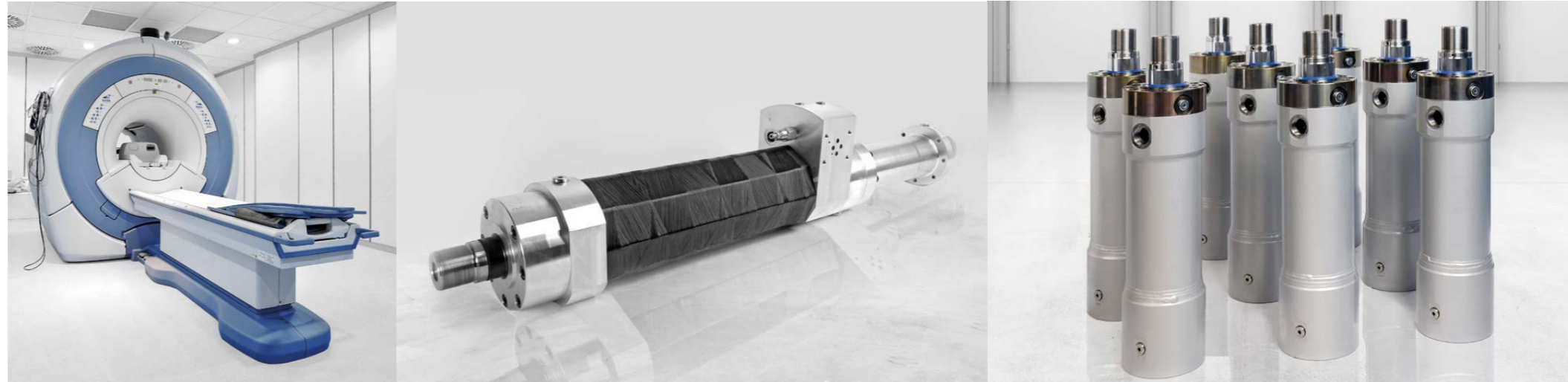

Special tasks? Individual solutions!

With decades of expertise in developing and manufacturing special solutions, our development team is always there for you. Whenever possible, we use minor modifications of our modular standard elements to adapt them to your requirements as cost-effectively as possible. If necessary, we can even develop entirely new solutions for you.

+ Serially produced cylinders: cost-effective, individual, application-optimised

Our extensive standard range is perfectly suited for many different applications. If a higher batch size is required repeatedly, it is worthwhile to design the cylinder to the exact specific requirement. In this respect, Hänchen takes a holistic approach in order to offer a cylinder with an optimised price-performance ratio.

- Low cylinder unit costs
- Cylinder can deliver exactly what the application requires
- Fast delivery times thanks to processes optimised for serial production
- Rapid supply of spare parts by keeping the seals in stock

- 1 MRT: serially produced cylinder for dosing the contrast medium
- 2 Helicopter test stand: lightweight cylinder with integrated piping and mounting plate, combined with the H-CFRP® material
- 3 Plastic blow-moulding machine: serially produced cylinders close the mould during the production process

+ Fluids and materials

The sealing materials available as standard are suitable for HLP/HLPD hydraulic fluids or fire-resistant fluids such as HFA, HFC, HFD. But even other fluids pose no problems for Hänchen, like for example:

- Silicone oils
- Bio-degradable fluids
- Brake fluids

The use of special design materials also enables application under extreme conditions, such as low temperature use, seawater resistance or heat radiation. The constructive lightweight design enables the creation of very light hydraulic cylinders and further optimisation by combining them with lightweight design materials.

Material properties

	Steel	Stainless steel	Cold resistant steel	Titanium	Aluminium	H-CFRP®
Tensile strength	++	+	++	+	-	++
Stiffness	++	++	++	-	--	++
Corrosion resistance	--	+/-	--	++	+	++
Weight	--	--	--	+/-	+	++
Magnetism	--	+	--	++	++	++
Temperature max.	200 °C	200 °C	200 °C	200 °C	100 °C	80 °C
Temperature min.	-20 °C	-40 °C	-40 °C	-40 °C	-40 °C	-40 °C

Special materials are possible for low temperature applications below -40 °C or for applications above 200 °C.

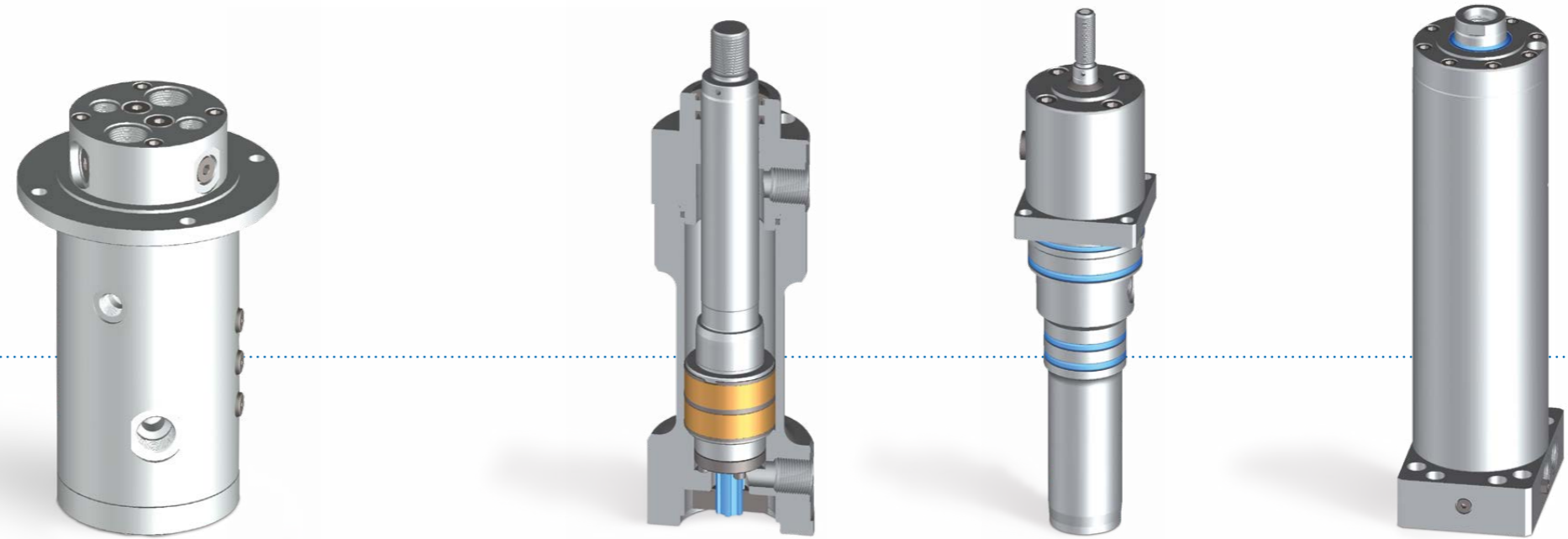

+ Individual designs

If simple adjustments don't suffice, we'll design complete cylinders to suit your requirements.

Whether you need cylinders with special damping, for dosing, injection, weight compensation or oscillation. Here you can see some examples for such special solutions.

Example 1: rotary feedthrough

The multi-channel rotary feedthrough offers a solution for the transfer of fluids between a fixed and a rotating assembly. These are particularly used in machines and other precise, fast-rotating systems. The fluid is fed into rotating channels and passes through these into the rotating body. Possible fields of application:

- Coolant supply in tool spindles
- Supply of hydraulic cylinders on rotating portals

Example 2: cylinder with anti-torsion mechanism

Piston rods in hydraulic cylinders are usually secured against torsion by means of mounting parts. If the rod is not fixed, torsion can occur. Even small external torques can be enough, and even the surface structure of the piston rod can cause torsion over the stroke. Mechanical devices can prevent this, even for very high torques. We select the best version for your application.

Example 3: screw-in cylinder

Hydraulic cylinders are mounted mechanically before establishing a hydraulic connection using hoses or pipes. A space-saving alternative are screw-in cylinders built into stepped bores using a stepped cylinder housing. Insertable in a block, this cylinder is usually integrated in a machine and protected from external influences. The advantages:

- Small construction volume
- Easy installation without screwed fittings

Example 4: hydraulic cylinders as guide pillar

The solution for a space-saving combination of linear movement and an exact guide: the guide pillar with the hardened surface and an integrated hydraulic cylinder. This allows precise guidance and movement of loads coupled with the piston rod without subjecting the cylinder to side loads.



For technical data about the guide pillar, please visit www.haenchen-hydraulic.com/industry/foundry-die-casting.html.



Keeps the position for you!



- 1 Grinding machine: positioning of ICE rail sleepers beds during machining
- 2 Ferry: lifting, lowering and fixing the bow and stern doors
- 3 Profiling machine: protection against front and side impact



Ratio-Clamp® can be installed to all hydraulic cylinders using flanges. As suitable accessories/tools, we can provide:

- Proximity switch (to show locking state)
- Control block (releases Ratio-Clamp® before cylinder starts moving)



You can find further information on Ratio-Clamp® in our brochure "Clamping unit".

The patented clamping unit Ratio-Clamp® serves to protect human, machine and tools in case of a power failure or system shutdown. It fixes axes during the process or for highly dynamic applications and test processes.

+ Safe advantages

- Can be used horizontally and vertically
- Can take tension and pressure in any direction
- Immediate clamping effect without further rod movement
- Energy-efficient thanks to pressureless clamping process

+ Use

- Fixation of all types of round rods in any position
- Out of a standstill
- Clamping force without energy supply for unlimited time
- An additional safety component for gravity loaded axes

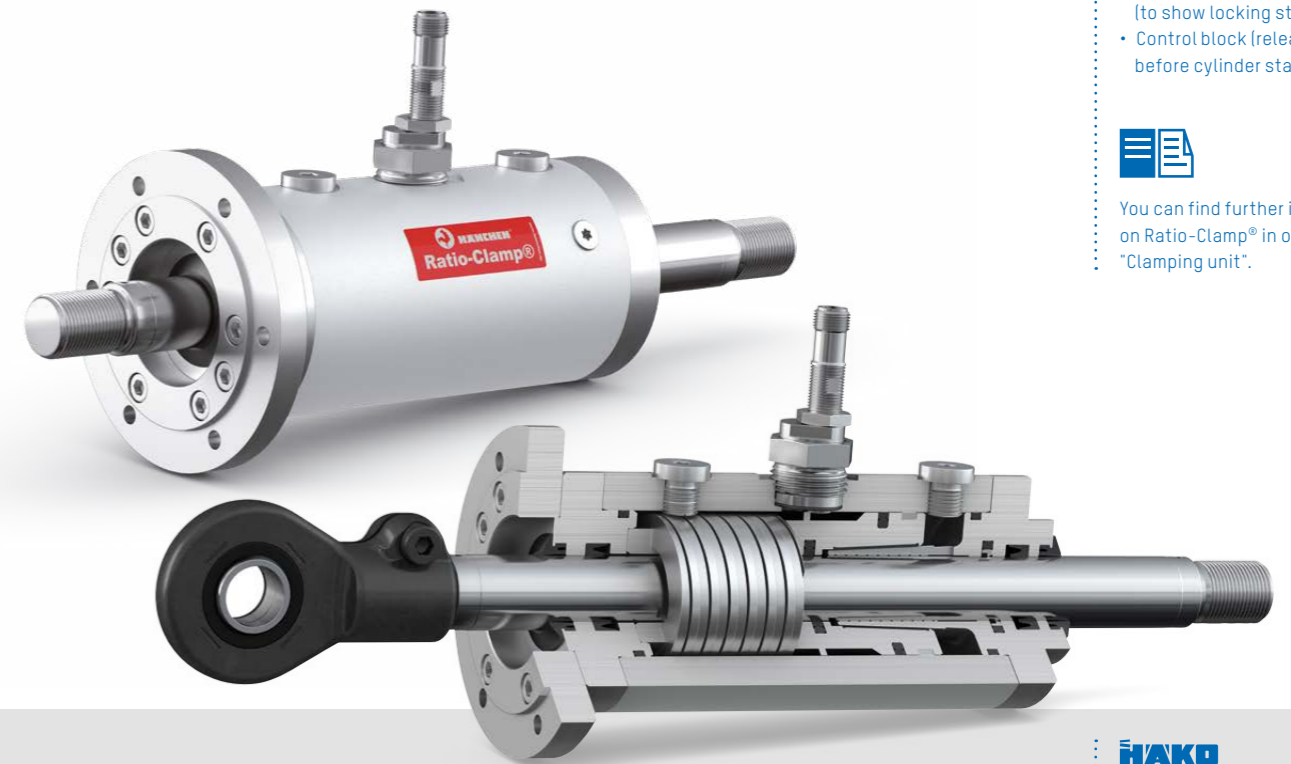

Technical data

Ratio-Clamp®	Rod Ø (mm)	Force (kN)
Standard design	16 – 160	1 – 750
Special solution	up to 300	up to 2,000

Suitable for: all hydraulic cylinders, round rods
 Certification: TÜV, DGUV test
 Sealing systems: Servocop®, pressure piston seal



You can find the exact dimensions and the data sheets in our product configurator at www.haenchen-hydraulic.com.



Change of application made easy.

If certain processes require more or less force or a different fluid, pressure transformers and fluid separators are a quick and cost-efficient solution. The secondary side can operate with almost any fluid, such as water, HFA, HFC, mineral oil or AdBlue®.

+ The perfect boost: pressure intensifier

Pressure intensifiers are the perfect solution when you need more pressure, and reconfiguring the entire system would be too complex. Perfect in clock mode for high-pressure compression forming, for bursting tests of hoses, pipes or containers, and closing or clamping tools or moulds.

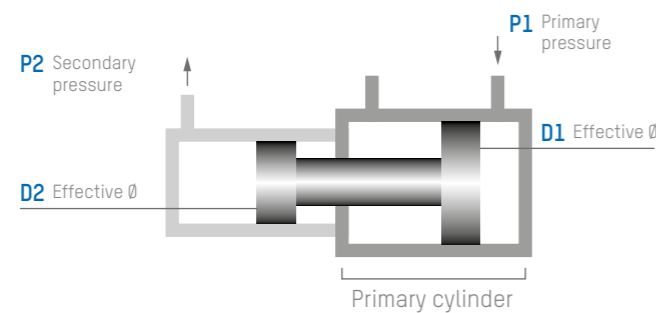

Design proposals

p2 (bar)	D1 (mm)	D2 (mm)	Transmission ratio	p1 (bar)	Dynamics
630	100	60	2.78	227	up to 20 Hz
	125	80	2.44	258	
	160	100	2.56	246	
1,600	125	50	6.25	256	up to 10 Hz
	160	60	7.11	225	
	200	80	6.25	256	
4,000	125	30	17.36	230	static
	160	40	16.00	250	
	200	50	16.00	250	

To design a pressure intensifier for a specific stroke and delivery volume, it is necessary to have the information on the fluid, compressibility and primary pressure.

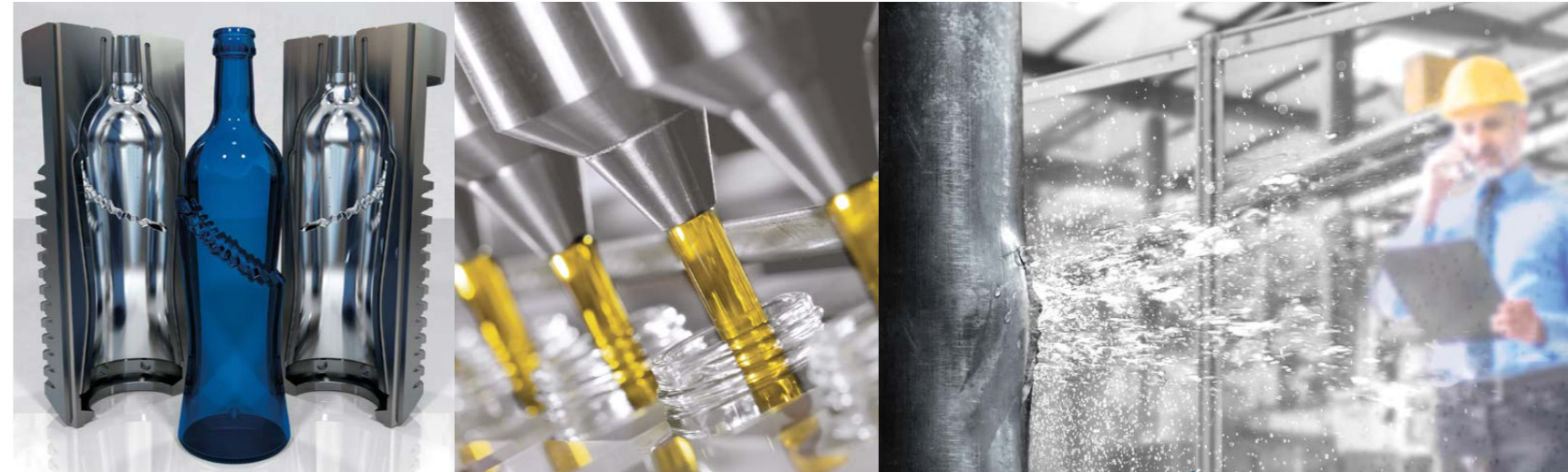

- 1 Pressure intensifier for very high mould closing pressures in hollow glass production
- 2 Precise dosing with fluid separator
- 3 Burst test: pipes are tested using pressure intensifiers

+ More precision: pressure reducer

For quick moving or exact control of fluids at low pressure, pressure reducers are the best choice – for instance for sensitive low pressure tests of heat exchangers, fittings or hot-water storage tanks.

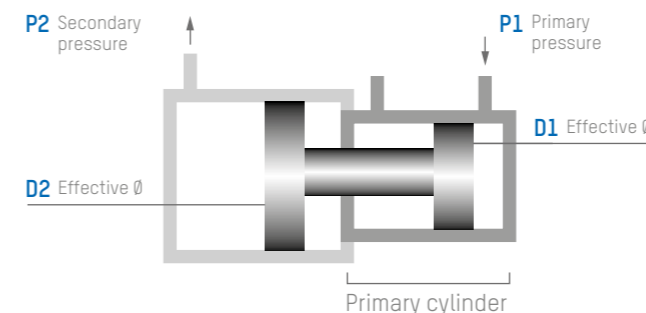

Design proposals

p2 (bar)	D1 (mm)	D2 (mm)	Transmission ratio	p1 (bar)
15	16	60	0.07	211
	20	80	0.06	240
	30	125	0.06	260
25	20	60	0.11	225
	25	80	0.10	256
	40	125	0.10	244
40	25	60	0.17	230
	30	80	0.14	284
	50	125	0.16	250

+ Clearly separated: fluid separator

For a change of fluids without its own hydraulic supply – the pressure remains the same on both sides. A complete separation of the two fluids is possible. For all pressure ranges and almost all fluids, e.g. for pressure cases in testing facilities for different fluids, or for separating two fluids, e.g. hydraulic oil to Skydrol®.

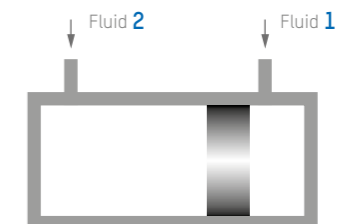

Design proposals

Nominal pressure p1 (bar)	Effective Ø (mm)
150	40
	50
	80
	125
300	50
	60
	100
	140



All sizes and pressures on request.

Don't hesitate to contact us, we will be pleased to advise you! You can find our contact details on the insert.



Individuality.
Our strength is your success.

The design and production for special engineering is one of Hänschen's strengths. Individual machine elements are an integral part in the implementation of special requests. We do not provide you standard catalogue products, but exactly what you need.

+ Made of metal

High-quality steel materials such as 20MnV6, 42CrMo4V, 16MnCr5, stainless steels such as 1.4571 or 1.4462, but also aluminium alloys or non-ferrous metals are the raw material for the production of:

- Rods, shafts and axes
- Sealing systems and guiding elements
- Mounting elements

+ Made of carbon

H-CFRP® is a composite of carbon fiber-reinforced plastic and other components with high load capacity developed by Hänschen and refined into a material. We use this hybrid carbon material to design and produce round components with and without metallic components.

- Rods, bars and tubes
- With pressure-resistant and liquid-tight coating
- Without coating, unsmoothed winding surface or honed
- With high-tensile bond between CFRP and metal



- 1 Support shaft for a test setup and receiving shaft for a textile machine
- 2 Carbon support structure for telescopic rods and push rods used in machine tools



For detailed information, please visit www.haenchen-hydraulic.com/machine-elements.html.

+ Our possibilities

In our machining centres, we can produce individual pieces or small series with up to Ø 600 mm and a length up to 400 mm. Our lathes can machine up to Ø 200 mm and a length of up to 3,500 mm.

Design and engineering drawing

We are happy to take over the development and design for your individual machine element or manufacture according to your model. We use modern methods such as FEM calculations and CAD/CAM.

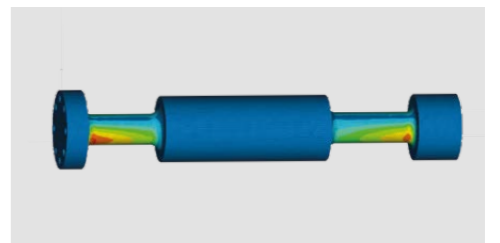

Production technologies

Machining with state-of-the-art turning, drilling and milling centres. Precision-finishing by internal and external honing, finishing and grinding. Solid, as hollow shaft or with deep-hole drilling – in all common ISO fits.

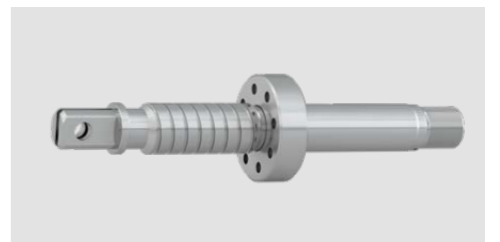

Coating

Anodised aluminium, hardened steel, hard-chrome plated or nickel plated – as your application requires. Bronze and synthetic layers can be fitted as sliding surfaces on the inside and outside.

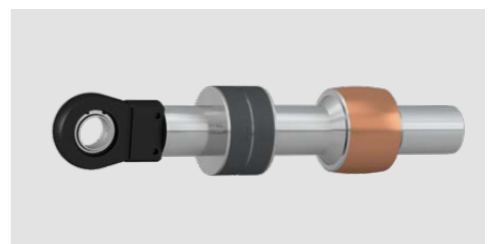

HäKo – the Hänchen configurator

Do you know exactly what you need? Then simply configure your products yourself: whether hydraulic cylinders, clamping units or mounting elements – our product configurator helps you to find the perfect solution for the requirements of your industry. Should you have any further questions, we will be glad to advise you personally.

Convince yourself of our product configurator HäKo.
You can access it through www.haenchen-hydraulic.com.



Technical data Hänchen hydraulic cylinders



+ Standard hydraulic cylinders

Bore (mm)	Rod Ø (mm)	SERIES 120		SERIES 300	
		Force F ₁ F ₂ (kN)	Max. pressure* (bar)	Force F ₁ F ₂ (kN)	Max. pressure (bar)
25	12	7.4 5.7	150	-	-
	16	7.4 4.3	150	14.7 8.7	300
32	16	12.1 9.0	150	-	-
	20	12.1 7.4	150	24.1 14.7	300
40	20	18.8 14.1	150	-	-
	25	18.8 11.5	150	37.7 23.0	300
	30	-	-	37.7 16.5	300
50	25	29.5 22.1	150	-	-
	30	29.5 18.8	150	58.9 37.7	300
	40	-	-	58.9 21.2	300
60	30	42.4 31.8	150	-	-
	40	42.4 23.6	150	84.8 47.1	300
	50	-	-	84.8 25.9	300
80	40	75.4 56.5	150	-	-
	50	75.4 45.9	150	150.8 91.9	300
	60	-	-	150.8 66.0	300
100	50	117.8 88.4	150	-	-
	60	117.8 75.4	150	235.6 150.8	300
	80	-	-	235.6 84.8	300
125	60	184.1 141.7	150	-	-
	80	184.1 108.7	150	368.2 217.4	300
	100	-	-	368.2 132.5	300
140	80	230.9 155.5	150	-	-
	100	230.9 113.1	150	461.8 226.2	300
160	80	301.6 226.2	150	-	-
	100	301.6 183.8	150	603.2 367.6	300
180	100	381.7 263.9	150	-	-
	120	381.7 212.1	150	763.4 424.1	300
200	100	628.3 471.2	200	-	-
	120	628.3 402.1	200	-	-
	140	-	-	942.5 480.7	300
220	120	760.3 534.1	200	-	-
	140	760.3 452.4	200	-	-
	160	-	-	1,140.0 537.2	300
250	120	981.7 755.6	200	-	-
	140	981.7 673.9	200	-	-
	180	-	-	1,472.0 709.2	300
300	160	1,413.7 1,011.6	200	-	-
	200	-	-	2,120.6 1,178.2	300

* When pivot mounted, the pressure is limited to 120 bar.

F₁ = Compressive force while the cylinder is extended | F₂ = Compressive force while the cylinder is retracted
With double-rod cylinders, retraction and extension corresponds to the value F₂.

+ Standard cylinders according to DIN & ISO

Bore (mm)	Rod Ø (mm)	SERIES 100	SERIES 160	SERIES 250	SERIES 550
		DIN 24336 100 bar Force F ₁ F ₂ (kN)	ISO 6020-1 160 bar Force F ₁ F ₂ (kN)	ISO 6022 250 bar Force F ₁ F ₂ (kN)	ISO 6022 250 bar Force F ₁ F ₂ (kN)
25	12	4.9 3.8	-	-	-
	14	-	7.9 5.4	-	-
	18	-	-	-	-
32	14	8.0 6.5	-	-	-
	18	-	12.9 8.8	-	-
	22	-	-	-	-
40	18	12.6 10.0	-	-	-
	22	-	20.1 14.0	-	-
	25	-	-	-	31.4 19.1
	28	-	-	-	-
	30	-	-	-	31.4 13.7
50	22	19.6 15.8	-	-	-
	28	-	31.4 21.6	-	-
	30	-	-	-	49.1 31.4
	32	-	-	49.1 29.0	-
	38	-	-	-	-
60	40	-	-	-	70.7 39.3
	50	-	-	-	70.7 21.6
	63	31.2 25.0	-	-	-
80	36	-	49.9 33.6	-	-
	40	-	-	77.9 46.5	-
	45	-	-	-	-
	50	50.3 40.1	-	-	-
	56	-	80.4 55.0	-	-
100	60	-	-	125.7 76.6	125.7 76.6
	63	-	-	-	-
	70	-	-	-	-
	80	-	-	-	125.7 55.0
	45	78.5 62.6	-	-	-
	56	-	125.7 86.3	-	-
125	60	-	-	-	196.3 125.7
	63	-	-	196.3 118.4	-
	70	-	-	-	-
	80	-	-	-	196.3 70.7
	100	-	-	-	-
140	56	122.7 98.1	-	-	-
	70	-	196.3 134.8	-	-
	80	-	-	306.8 181.1	306.8 181.1
	90	-	-	-	-
160	100	-	-	-	306.8 110.4
	100	-	-	-	384.8 188.5
200	90	-	321.7 219.9	-	-
	100	-	-	502.7 306.3	-
200	110	-	502.7 350.6	-	-
	125	-	-	785.4 478.6	-

+ Test actuators

SERIES 320						
Rod Ø (mm)	Type	Bore (mm)	Force (kN) 210 bar	Force (kN) 320 bar	Stroke (mm)	
25	strong	28 – 45	2.6 – 23.1	4.0 – 35.2	50 – 170	
30	strong	34 – 55	4.2 – 35.0	6.4 – 53.4	50 – 220	
40	strong	45 – 70	7.0 – 54.4	10.7 – 82.9	50 – 270	
50	strong	56 – 80	10.5 – 64.3	16.0 – 98.0	50 – 450	
63	strong	70 – 110	15.4 – 134.1	23.4 – 204.4	50 – 450	
80	slim	90 – 120	28.0 – 131.9	42.7 – 201.1	50 – 450	
80	strong	90 – 150	28.0 – 265.5	42.7 – 404.6	50 – 450	
100	slim	110 – 150	34.6 – 206.2	52.8 – 314.2	50 – 450	
100	strong	110 – 175	34.6 – 340.2	52.8 – 518.4	50 – 450	
125	slim	140 – 175	65.6 – 247.4	99.9 – 377.0	50 – 450	
125	strong	140 – 200	65.6 – 402.0	99.9 – 612.6	50 – 450	
160	slim	180 – 220	112.2 – 376.0	170.9 – 573.0	50 – 450	
160	strong	200 – 260	237.5 – 692.7	361.9 – 1,055.6	50 – 450	
200	slim	240 – 280	290.3 – 633.3	442.3 – 965.1	50 – 450	
200	strong	250 – 320	371.1 – 1,029.2	565.5 – 1,568.3	50 – 350	

strong: massiv construction (e.g. vertical installation)
 slim: lighter construction (e.g. horizontal installation with spherical rod eyes)

+ Square hydraulic cylinders

SERIES 120			
Bore (mm)	Rod Ø (mm)	Stroke (mm)	Force F ₁ (kN)
12	6	30	1.4
16	8	40	2.4
20	10	50	3.8
25	12	50	5.9



Basis for a successful collaboration.

Do you need support? At Hänchen, we offer you comprehensive all around advice and fast support.

For all questions and problems regarding virtually anything, such as accessories and tools, we are always at your side. Because we want to give you the best drive solution and smooth test scenarios for your individual requirements: by minimising the time required for installation and maintenance, and providing the best functional reliability.

At www.haenchen-hydraulic.com, you will find further information on:

- Technical information
- Applications
- Installation and maintenance



If required, we also supply suitable accessories: from mounting plates, sensor technology, spherical rod eyes and flanges to clevis brackets.



Do you need support or further dimensions? Contact us: we provide you with comprehensive advice and support you during the design phase. You can find our contact details on the insert.



You can find design and calculation assistants together with data sheets in our product configurator at www.haenchen-hydraulic.com.

ADDRESSES & CONTACT

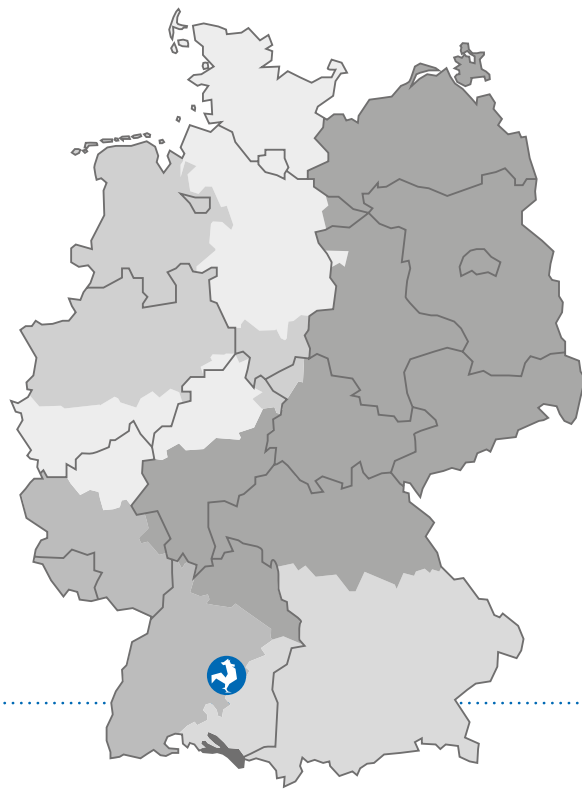

Hänchen in Germany...

Herbert Hänschen GmbH & Co. KG

Brunnwiesenstr. 3, 73760 Ostfildern

Postfach 4140, 73744 Ostfildern

Germany

Fon +49 711 44139-0

info@haenchen.de

www.haenchen-hydraulic.com

ADDRESSES & CONTACT

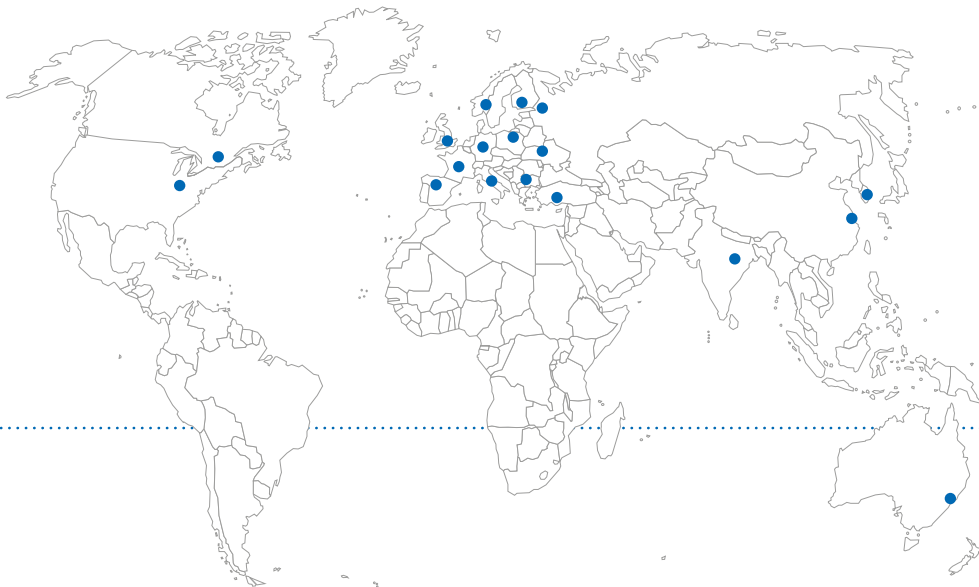

Hänenchen around the world...

AUSTRALIA

Hylec Controls Pty Ltd
8 Melissa Street
Auburn NSW 2144
Fon +61 2 9645 4777
Fax +61 2 9645 3480
sales@hyleccontrols.com.au

AUSTRIA

Hänenchen Hydraulik AG
Postfach 141
Hungerbühlstr. 17
8501 Frauenfeld/Switzerland
Mobil +43 664 4396649
ggruber@haenchen.ch

BELGIUM

Doedijns Fluid Industry NV/SA
Parc Industriel
Allee II no. 4
4540 Amay
Fon +32 85 51 96 96
Fax +32 85 51 96 97
info@fluidindustry.co

BOSNIA-HERZEGOVINA see Slovenia

CANADA

Abacus Hydraulics Ltd.
835 Ellingham Ave., Pointe-Claire,
Montreal, Q.C.
CANADA H9R 5E8
Fon +1 514 620-3113
Fax +1 514 620-3115
info@abacus-hydraulics.com

CHINA

**Haenchen (Shanghai) Hydraulic
Equipment Co., Ltd**
2F Building 29 #18
No. 99 Chunguang Road
201101 Shanghai
Fon +86 21 52967720
Fax +86 21 51564120
office-china@haenchen.de
www.haenchen.cn

CROATIA

see Slovenia

CZECH REPUBLIC

Mister Karel Srnsky
Křenkova 150
592 31 Nové Město na Moravě
Mobil +420 724 762 329
srnskykarel@gmail.com

FINLAND

ATOY Automotive Finland Oy
Ruukintie 7-9
02330 Espoo
Fon +358 407693643
markku.arosarka@atoy.fi

FRANCE

HAENCHEN HYDRAULIQUE S.A.R.L.
6 rue des Saules
67170 Wingersheim les quatre Bans
Fon +33 388 261808
Fax +33 388 268513
contact@haenchen.fr
www.haenchen.fr

GREAT BRITAIN

Savery Hydraulics
Grovelands
Longford Road, Exhall
Coventry, CV7 9NE
Fon +44 24 7664 5555
Fax +44 24 7636 6879
adam.poole@savery.co.uk

INDIA

Mister Sanjay Piparsania
28/9, Nehru Nagar (EAST)
Bhilai 490 020 (C.G.)
esspee28@gmail.com

ITALY

see Switzerland

MACEDONIA

see Slovenia

MONTENEGRO

see Slovenia

NETHERLANDS

R & S Hydrauliek B.V.
Ohmstraat 42
3335 LT Zwijndrecht
Fon +31 78 623 1818
Fax +31 78 623 1819
info@rs-hydrauliek.nl

NORWAY

Egil Eng & Co. AS
Jernkroken 7
0976 Oslo
Fon +47 22 90 05 60
Fax +47 22 16 15 55
thomas@egileng.no

POLAND

Biuro Handlowe Kurant-trade
ul. Kolejowa 24
59-100 Polkowice
Fon +48 663 022 829
Fax +48 768 456 494
office@kurant-trade.pl

PORTUGAL

SAICIPO Lda.
Rua da Anta, 356 - Armazém C
4475-104 Maia
Fon +351 229 437 140
Fax +351 229 437 149
geral@saicipo.pt

ROMANIA

PLURITECH srl
str. Aleea Budacu nr. 3, bl. M5
sc. 2, et. 1, ap. 25, sector 3
030461 Bucuresti
Fon +40-031.409.5085
office@pluritech.ro

RUSSIA

AVA Hydrosystems, JSC
2, Kondratievsky Pr., 195009
St. Petersburg
Fon +7 812 4490335
Fax +7 812 4492182
alexunov@hydrosystem.ru

SERBIA

see Slovenia

SLOVAKIA

see Czech Republic

SLOVENIA

Nevoja d.o.o.
Gregorciceva ulica 29a
2000 Maribor
Fon +386 2 234 85 50
Fax +386 2 234 85 51
dragan.grglc@nevoja.si

SOUTH KOREA

Dynatec Co., Ltd.
A-1418, Samho Center Bd. 83
Nonhyeonro Seochoogu
Seoul, 65535
Fon +82 2 579-2744
Fax +82 2 579-2745
call@dynatec.co.kr

SPAIN

HRE Hidraulic, S.L.
C/Ibaitarte, 21
20870 Elgoibar (Gipuzkoa)
Fon +34 943 742130
Fax +34 943 742708
j.alberdi@hre.es

SWEDEN

AB Swedec Automation
Hedeforsvägen 2
443 61 Stenkullen
Fon +46 302 236 50
Fax +46 302 228 54
info@swedec.se

SWITZERLAND

Hänenchen Hydraulik AG
Postfach 141
Hungerbühlstr. 17
8501 Frauenfeld
Fon +41 52 720 56 00
Fax +41 52 720 56 08
info@haenchen.ch
www.haenchen.ch

TURKEY

Rota Teknik Mak. San ve Tic A.Ş.
Bostancı Yolu , Kuru Sok. No: 17
34776 Y. Dudullu Ümraniye/Istanbul
Fon +90 216 526 00 30
Fax +90 216 314 31 00
fatihozcan@rotateknik.com.tr

UKRAINE

Hydro Max Fluid Power
143, Prilutskaya str.
16600 Nezin, Chernigovskaya
Fon +380 4631 311 11
Mobil +380 50 311 98 86
antonz@hydromax.com.ua

USA

IC Fluid Power, Inc.
63 Dixie Highway
Rossford, Ohio 43460
Fon +1 419 661 8811
Fax +1 419 661 8844
us@icfluid.com

Herbert Hänchen GmbH & Co. KG
Brunnwiesenstr. 3, 73760 Ostfildern
Postfach 4140, 73744 Ostfildern
Germany
Fon +49 711 44139-0
info@haenchen.de
www.haenchen-hydraulic.com



HÄNCHEN®